

Solarseeker



MANUAL

Simple and Smart

Solarseeker Co.,Ltd

Specialized In Making Solar Pump Inverter



Contents

Quick Start	1
1 Operation	2
1.1 Button	2
1.2 Data	2
2 Protection	2
3 Parameter	3
4 Specification	6
4.1 Designation	6
4.2 Specification	6
5 Installation	8
5.1 Main Circuit Terminals	8
5.2 Control board Terminal	10
6 Keypad	12
7 Dimension	14
8 Alarm signal	16
9 Customer Installation Record	17

Quick Start

Model	SP1	SP2	SP3	SP4
Input DC Range(V)	170-800			270-800
MPPT Range(V)	170-800			270-800
Recommended Input DC(V)	330-800	330-800	330-800	540-800
Input AC(V)	220	220	220	380
Input AC Connect	Single Phase	Single Phase	Three Phases	Three Phases
Output AC(V)	220	220	220	380
Output AC Connect	Single Phase	Three Phases	Three Phases	Three Phases
Power Range(kW)	0.75 - 7.5	0.75 -7.5	0.75 - 7.5	0.75 - 250
Recommended Configuration	<p>Inverter power one level higher than pump power Solar panel power 2.0 times of pump power when pump power below 4kW. Solar panel power 1.3 times of pump power when pump power over 2.2kW.</p>			
Terminal For AC Input	<p>Please connect X4 and COM terminal when inverter get AC power input. Do not input AC power and DC power (from solar panel) at the same time to inverter, unless install optional device.</p>			
Failure Signal Lamp	<p>Terminal (TA, TB, TC, 24V, COM) can light the lamp (green running and red alarm signal) automatically and easily in control system.</p>			
Wiring	<p>Please do not connect terminals (R S T U V W + -) directly because short circuit will damage inverter.</p>			
Start Automatically	<p>When inverter start working automatically with weak sunshine, inverter will start and stop frequently too many times. It will reduce inverter working life. Please set parameter P28.03 to protect inverter.</p>			
Not output	<p>When inverter shows alarm signal, fan keep running, but inverter stop outputting voltage and frequency.</p>			
G type Inverter	<p>Inverter is G type with bigger current and longer lifespan while some other brands choose P type with less lifespan and cost.</p>			

1 Operation

1.1 Button

1. When P28.01=1 (default setting), inverter start working automatically once it get power. When P28.01=0, please press “**RUN**” button to start inverter.
2. Keypad will show data in turn. If you press  button, it will always shows same data.

1.2 Data

When inverter is in standby model, keypad will show the specification in turn

Solar panel DC voltage
Maximum output frequency
Output current

When inverter is outputting power, keypad will show the specification in turn

Solar panel DC voltage
Output frequency
Output current

2 Protection

Minimum frequency	If output frequency is lower than 35Hz for 60s, inverter will stop working for 300s and restart automatically.
Dry running	If output current smaller than the value (parameter 28.13) for 60s, inverter will stop working for 300s and restart automatically.
Over voltage	If DC voltage from solar panel is over 800V, inverter will stop working.
Tank full	If float switch sensor reach high position, sensor connect X2 and COM terminal. After sensor disconnect X2 and COM terminal, inverter will wait for 900s more and restart automatically.
Well empty	If floating switch sensor reach low position, sensor connect inverter X3 and COM terminal. After sensor disconnect X3 and COM terminal, inverter will wait for 900s more and restart automatically.

3 Parameter

Note: Parameters can be set only when inverter stop outputting.

No	Name	Detail	Range	Default
P28.01	Run command	0.Keypad; 1.Run automatically when power on; 2.Control board terminal; 3.Communication channel. Only one way can start inverter at the same time. Red button "STOP" can stop inverter working all the time.	0-3	1
P28.03	Waiting time in automatic model	0.10s; 1.30s; 2.60s; 3.90s; 4.180s; 5.300s; 6.600s; (Recommended value) 7.1200s; 8.1800s; If set P28.01=1 and power on, inverter will wait for some time and start working automatically.	0-8	0
P28.04	Maximum output frequency	Choose inverter maximum output frequency.	0-70	50
P28.05	Minimum output frequency	0.45Hz; 1.40Hz; 2.35Hz; 3.30Hz; 4.25Hz; 5.20Hz; 6.15Hz; 7.10Hz; Output frequency drops below 35Hz for 60s, inverter show alarm signal "111" and stop working. 35Hz depends on P28.05. 60s depends on P28.06.	0-7	7

P28.06	Delay time of minimum frequency	Output frequency drops below 35Hz for 60s, inverter show alarm signal "111" and stop working. 35Hz depends on P28.05. 60s depends on P28.06.	0-65535	60
P28.07	Restart time after minimum frequency	After alarm signal "111" last for 300s, inverter will restart automatically.	0-65535	300
P28.12	Dry running protection	0 Invalid; 1 Enable.	0-1	0
P28.13	Current of dry running	If inverter output current less than P28.13 value (Unit:Ampere) for 60s, inverter will show alarm signal "222" and stop. 60s depends on P28.14.	0-6553.5	/
P28.14	Protection time of dry running	If inverter output current less than P28.13 value (Unit:Ampere) for 60s, inverter will show alarm signal "222" and stop. 60s depends on P28.14.	0-6553.5	60
P28.15	Interval time of dry running restart	After alarm signal "222" last for 300s, inverter will restart automatically.	0-65535	300
P28.18	Motor rated power	Unit: kW	/	/
P28.19	Motor rated voltage	Unit: V	/	/
P28.20	Motor rated current	Unit: A	/	/
P28.21	Motor rated speed	Unit: rpm	/	/
P28.22	Parameter reset	0 Invalid; 1 Enable.	0-1	0
P28.23	Software version	/	/	/
P28.24	ACC time	The time (Unit:second) if inverter speed up from 0Hz to highest frequency (P28.04).	/	25
P28.25	DEC time	The time (Unit:second) if inverter speed down from highest frequency (P28.04) to 0Hz.	/	10

P28.26	Timing	Inverter give fault "END" when accumulated working time reach P28.26 value(Unit:hour).	0-65535	0
P28.27	Password	Input password then inverter parameter can be revised.	0-65535	0
P28.28	Highest temperature	The highest temperature (Unit:Centigrade) inside of inverter.	/	/
P28.30	Delay time of full water level signal	Inverter will show "555" alarm signal if full water signal last 5s.	0-1000	5
P28.31	Restart time after 555 alarm signal	If inverter don't receive full water signal any more, inverter will wait for 900s and restart working.	0-1000	900
P28.32	Delay time of low water level signal	Inverter will show "777" alarm signal if low water signal last 5s.	0-1000	5
P28.33	Restart time after 777 alarm signal	If inverter don't receive low water signal any more, inverter will wait for 900s and restart working.	0-1000	900
P28.39	Single phase pump model	0 Invalid; 1 Enable. Take out capacity in pump and set P28.39=1, inverter will start pump easier.	0-1	0
P28.44	Water level sensor logic	2 Make X2 logic opposite; 4 Make X3 logic opposite; 6 Make X2 and X3 logic opposite. With default function sensor connect X2 and Com, inverter will show alarm and stop working. If you need opposite logic (sensor disconnect X2 and Com then inverter show alarm), please set parameter as 2. If you need same function on X3, please set parameter as 4.	0-6	10F
P28.46	Temperature to start fan	When the internal temperature rises to 50 degrees, fan start running.	20-100	50

4 Specification

4.1 Designation

SP X XRX

① ② ③

Sign	Identification	Description	Content
①	SP	Series name	Solar pumping series
②	X	Voltage degree	4: 380V/three phase input/ three phase output 3: 220V/three phase input/ three phase output 2: 220V/single phase input/ three phase output 1: 220V/single phase input/ single phase output
③	XRX	Output power	0R7: 0.75kW 1R5: 1.5kW 002: 2.2kW 004: 4kW 250: 250kW

4.2 Specification

Voltage Degree	220V	380V
Maximum Input DC Voltage	800V	
Minimum Input DC Voltage	170V	270V
MPPT Voltage	170-800V	270-800V
Recommended DC Voltage	330-800V	540-800V

Model	Input AC Voltage(V)	Input AC Current (A)	Output AC Current (A)	Panel Power (kW)	Pump Power (kW)
SP10R7	220	12	8	2.7	0.4
SP11R5	220	16	10	2.7	0.7
SP1002	220	24	14	3.0	1.5
SP1004	220	30	18	4.4	2.2

SP1005	220	37	25	8.0	4.0
SP1007	220	48	32	11.0	5.5
SP20R7	220	11	5	0.8	0.4
SP21R5	220	18	8	1.4	0.7
SP2002	220	24	10	3.0	1.5
SP2004	220	36	17	4.4	2.2
SP2005	220	60	25	5.2	4.0
SP2007	220	70	32	11.0	5.5
SP30R7	220	7	5	0.8	0.4
SP31R5	220	11	8	1.4	0.7
SP3002	220	14	10	3.0	1.5
SP3004	220	21	17	4.4	2.2
SP3005	220	28	25	5.2	4.0
SP3007	220	35	32	7.2	5.5
SP40R7	380	4	2	0.8	0.4
SP41R5	380	5	4	1.4	0.7
SP4002	380	6	5	3.0	1.5
SP4004	380	11	9	4.4	2.2
SP4005	380	15	13	5.2	4.0
SP4007	380	21	17	7.2	5.5
SP4011	380	26	25	10	7
SP4015	380	35	32	14	11
SP4018	380	39	37	20	15
SP4022	380	47	45	23	18
SP4030	380	62	60	29	22
SP4037	380	76	75	39	30
SP4045	380	92	91	48	37
SP4055	380	113	112	59	45
SP4075	380	157	150	72	55
SP4090	380	180	176	98	75
SP4110	380	214	210	117	90
SP4132	380	256	253	143	110
SP4160	380	307	304	172	132
SP4200	380	385	377	208	160
SP4220	380	430	426	260	200
SP4250	380	468	465	286	220

5 Installation

5.1 Main Circuit Terminals

SP1

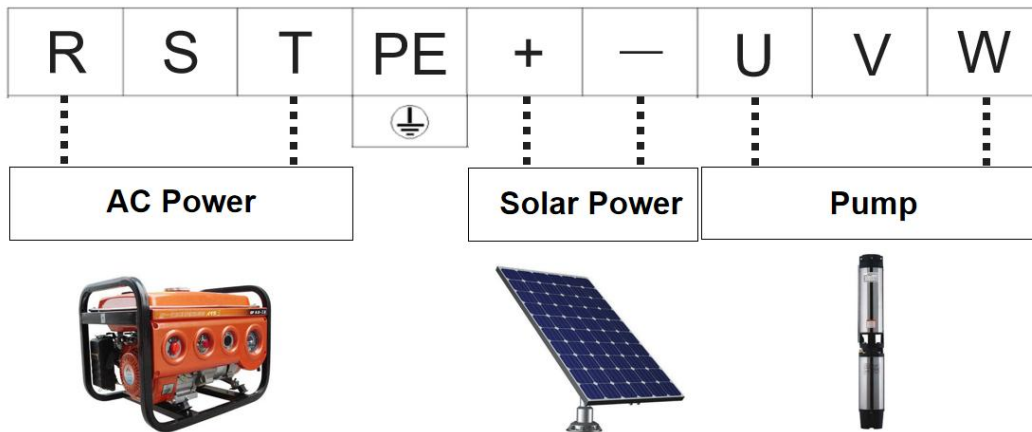

SP2

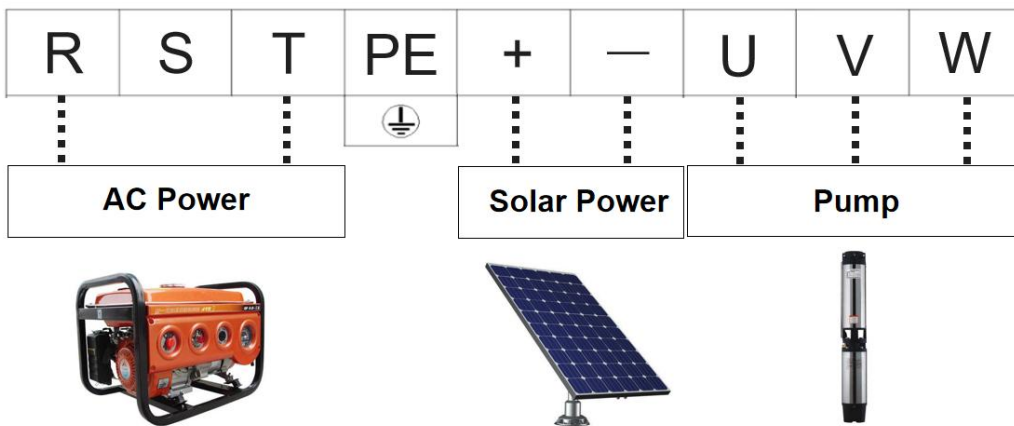

SP3

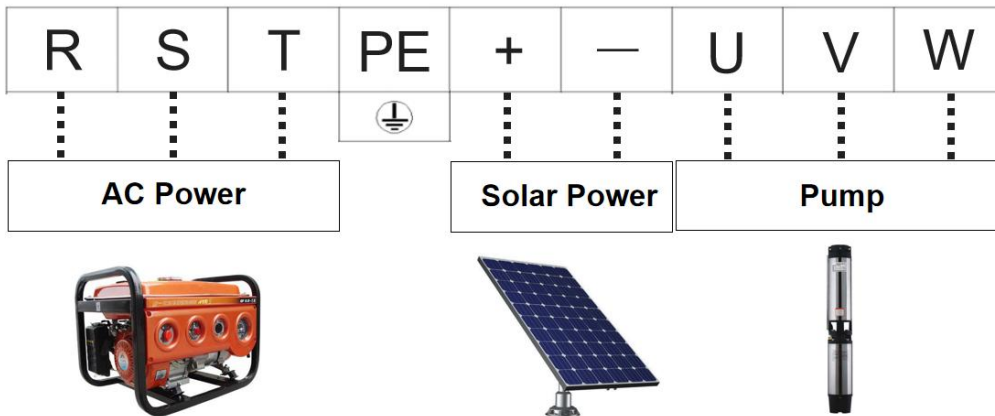

SP4

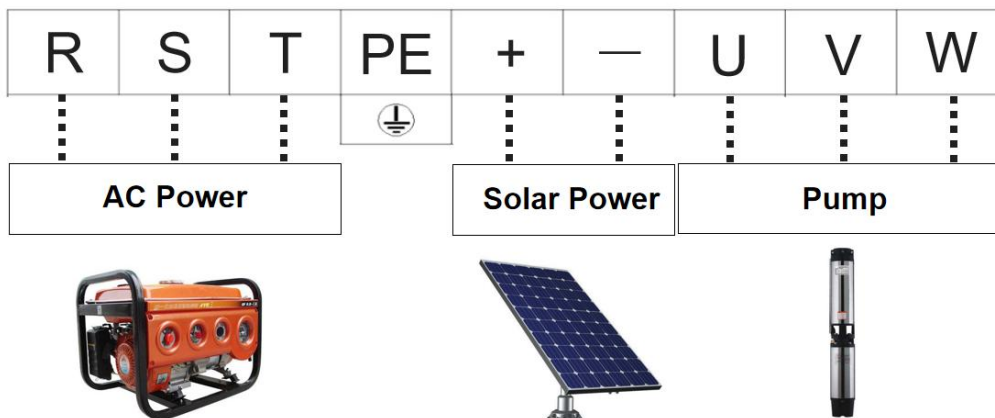

Terminal symbol	Terminal wiring
R S T	AC power input terminals for three phases.
R T	AC power input terminals for single phases.
+ -	DC input terminals for solar DC power(Do not charge inverter by generator and solar panel at the same time unless you add optional device).
PE	Grounding terminal.
U V W	AC power output terminals for three phases.
U W	AC power output terminals for single phases, if can not start single phase pump please take out capacity, change the wiring as photo below, and set P28.39=1.
PB	Invalid terminal.

5.2 Control board Terminal

+24V	Y1	Y2	X1	X2	X3	X4	AO	485-	485+
ROA	ROB	ROC	COM	X5	X6	GND	AI1	AI2	+10V

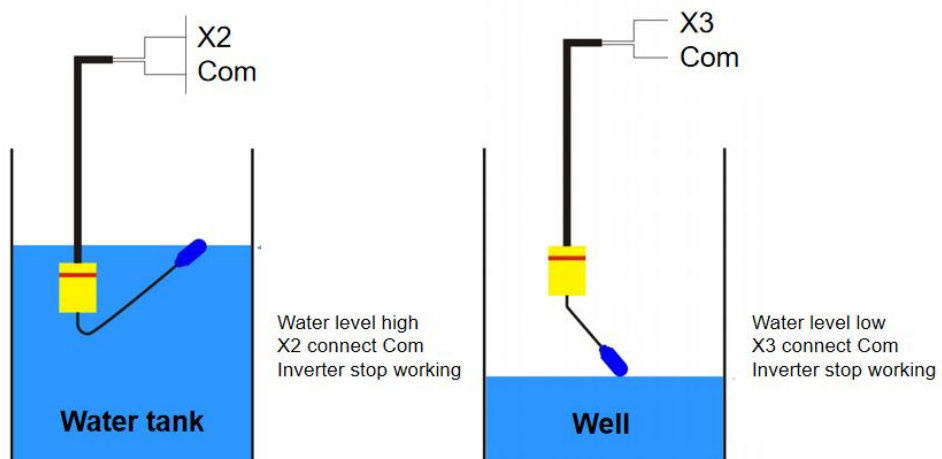
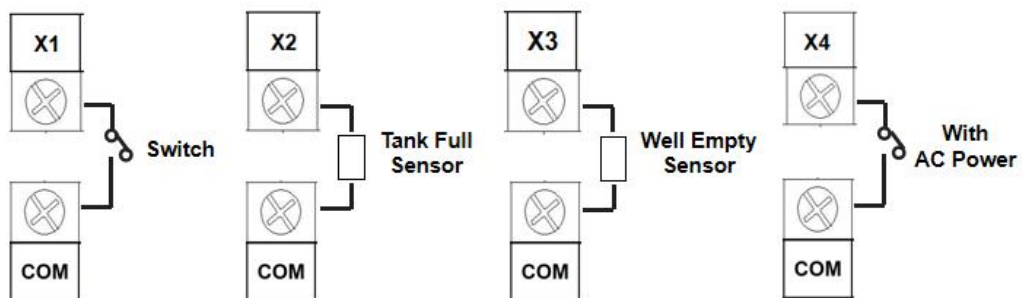

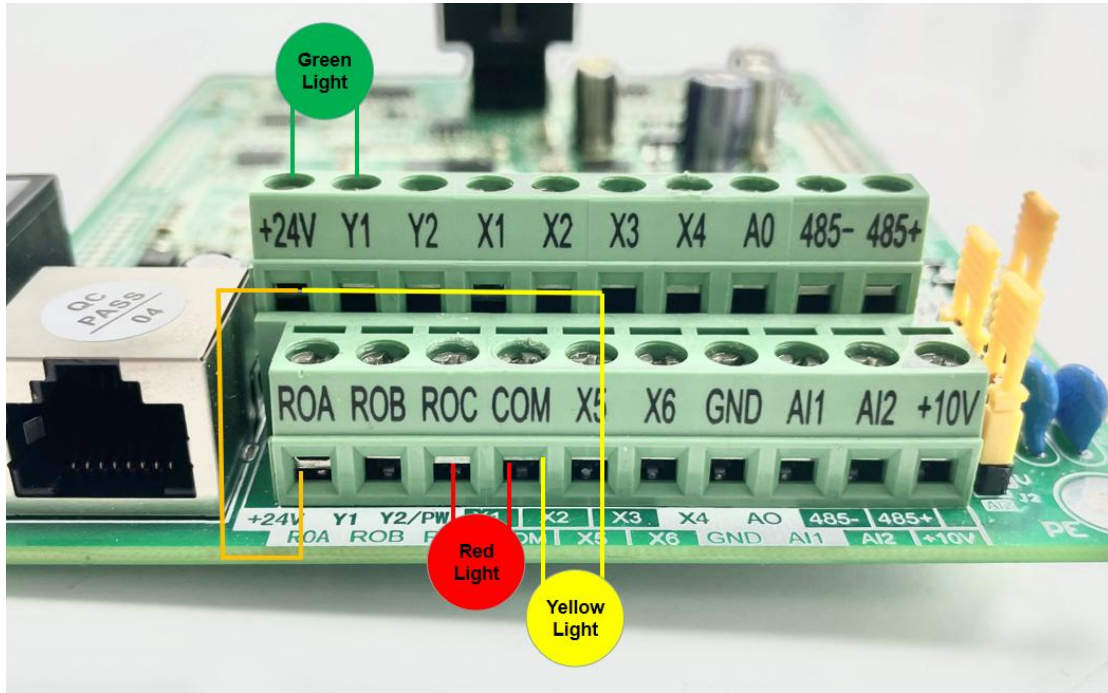

Terminal	Terminal function description
X1	Set Parameter P28.01=2 for terminal control, connect X1 and COM terminal together, inverter will run.
COM	
X2	Float switch sensor, connect X2 and COM terminal for full water signal or empty water signal, inverter will stop working after 5s, show alarm signal "555". After that if sensor disconnect X2 and COM terminal, inverter will restart automatically after 900s.
COM	
X3	When inverter get AC power input from RST terminal, please connect X3 and COM terminal.
COM	
TA TB	When inverter get power, yellow lamp will light if yellow lamp connect +24V and COM terminal.
TA TC	
Y1	When inverter show alarm signal (444/888/999), green lamp will light if green lamp connect +24V and Y1 terminal.
24V	When inverter start working or showing alarm signal (111/222/333/555/777), red lamp will light if red lamp connect TC and COM terminal, +24V and TA connect together.
COM	

6 Keypad

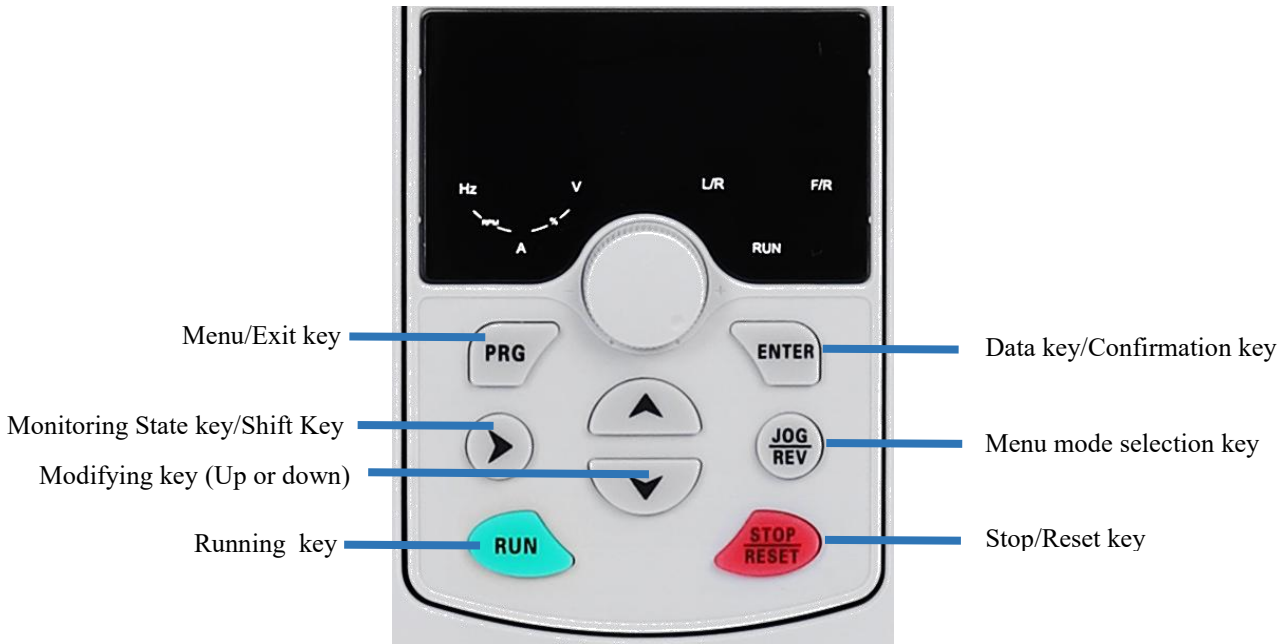

- **RUN:**
OFF indicates that the frequency inverter is in the stop state and ON indicates that the frequency inverter is in the running state.
- **LOCAL:**
It indicates whether the frequency inverter is operated by operation keypad, terminals or remoter (communication). OFF indicates keypad operation control state; ON indicates terminals operation control state; Blinking indicates remote operation control state.
- **DIR:**
It is Forward/Reversal indicator, ON indicates forward rotation.
- **TRIP:**
When the indicator is ON, it indicates torque control mode. When the indicator is blinking slowly, it indicates the auto-tuning state. When the indicator is blinking quickly, it indicates the fault state.
- **Unit indicator**
 - ① Hz: frequency unit;
 - ② A: Current unit;
 - ③ V: Voltage unit.
- **Digital display area**
The 5-digit LED display is able to display the set frequency, output frequency, monitoring data and fault codes.
- **Description of Keys on the Operation panel (keypad).**

Key	Name	Function
PRG/ESC	Programming	Enter or exit menu level I.
DATA/ENTER	Confirmation	Enter the menu interfaces level by level, and confirm the parameter setting.
△	Increment	Increase data or function code.
▽	Decrement	Decrease data or function code.
▷▷	Shift	Select the displayed parameters in turn in the stop or running state, and select the digit to be modified when
RUN	RUN	Start the frequency inverter in the operation panel control
STOP/RESET	Stop/Reset	Stop the frequency inverter when it is in the running state and perform the reset operation when it is in the fault state. The functions of this key are restricted by b9-00.
Rotary Knob	/	No function, for back up.
QUICK	Menu mode selection	“QUICK” and “Decrement” work together more than 5s will make parameter back to default value. function).

- Viewing and Modifying Function Codes

The operation panel adopts three-level menu.

The three-level menu consists of function code group (Level I), function code (Level II), and function code setting value (level III), as shown in the following figure.

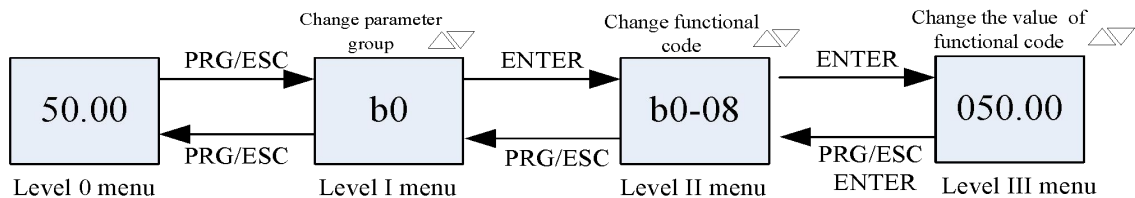

We can return to level II menu from Level III menu by pressing PRG or ENTER.

The difference between them is:

After you press ENTER, the system saves the parameter setting first, and then goes back to Level II menu and shifts to the next function code.

After you press PRG, the system does not save the parameter setting, but directly returns to Level II menu and remains at the present function code.

Under the Level III state, if there is no blinking digit of this parameter, then it indicates that the parameter can not to be modified. The possible reasons are:

- ① This function code is a non-modifiable parameter, such as the actual testing parameters, operation records, etc.
- ② This function code cannot be modified under the running state, but can modify after stopping.

7 Dimension

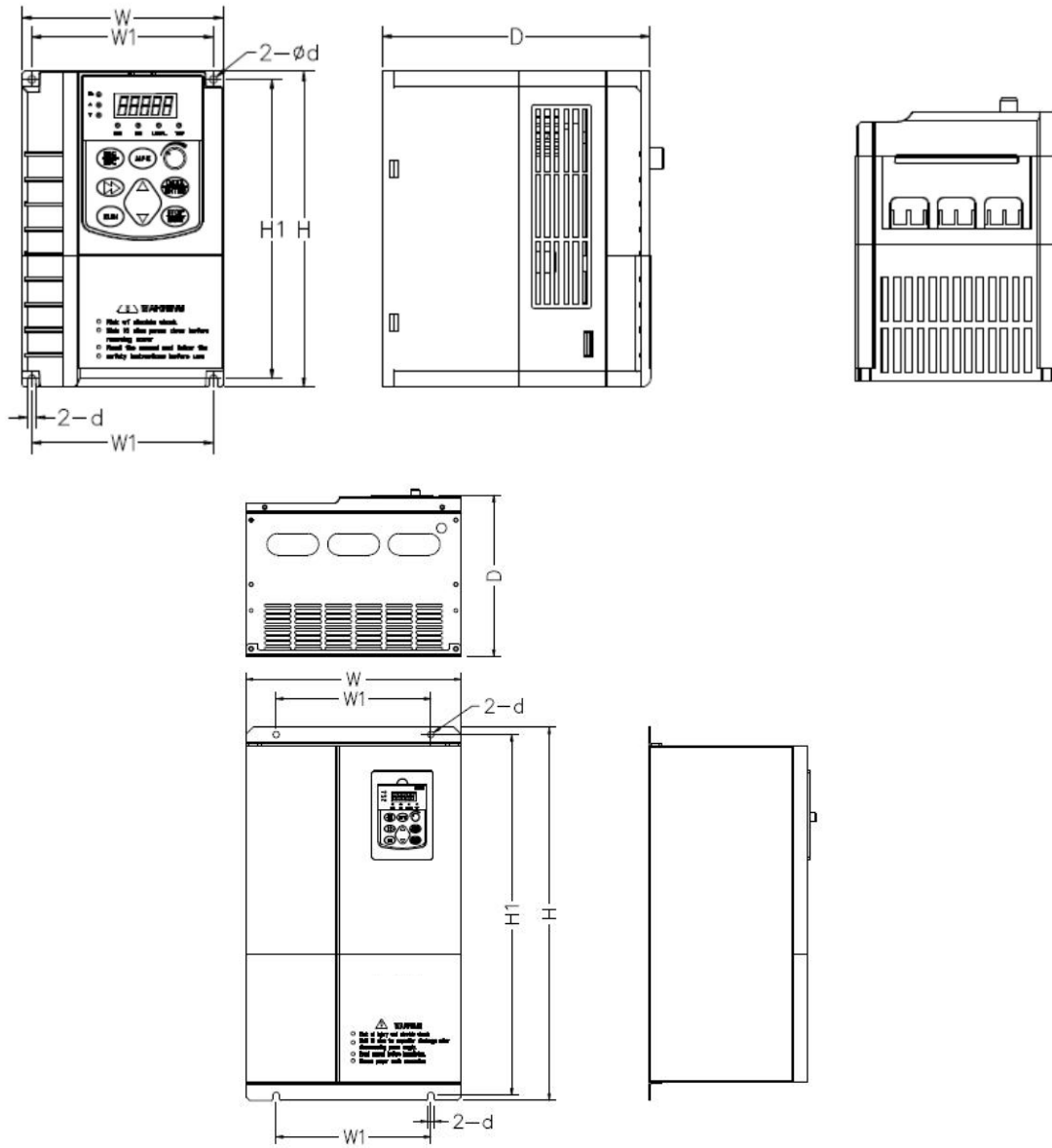

Model	W (mm)	D (mm)	H (mm)	Packing Size (mm)	Gross Weight
SP10R7	118	167	185	220*172*222	2.0
SP11R5	118	167	185	220*172*222	2.0
SP1002	118	187	185	220*172*222	2.2
SP1004	160	190	247	310*218*245	3.4
SP1005	160	190	247	310*218*245	3.8
SP20R7	118	167	185	220*172*222	2.0
SP21R5	118	167	185	220*172*222	2.0
SP2002	118	167	185	310*218*245	3.4
SP2004	118	187	185	310*218*245	3.8
SP2005	160	190	247	395*295*280	6.9
SP2007	220	205	320	395*295*280	7.1
SP31R5	118	167	185	220*172*222	2.0
SP3002	118	167	185	220*172*222	2.0
SP3004	160	190	247	310*218*245	3.4
SP3005	160	190	247	310*218*245	3.8
SP3007	220	205	320	395*295*280	6.9
SP41R5	118	167	185	220*172*222	2.0
SP4002	118	167	185	220*172*222	2.0
SP4004	118	167	185	220*172*222	2.0
SP4005	118	187	185	220*172*222	2.2
SP4007	160	190	247	310*218*245	3.4
SP4011	160	190	247	310*218*245	3.8
SP4015	220	205	320	395*295*280	6.9
SP4018	220	205	320	395*295*280	7.1
SP4022	220	205	320	395*295*280	7.1
SP4030	255	235	432	521*369*329	14.6
SP4037	255	235	432	521*369*329	15.8
SP4045	275	234	452	530*388*329	18.0
SP4055	300	260	518	591*411*351	31.0
SP4075	390	300	620	738*508*418	50.0
SP4090	390	300	620	738*508*418	52.0
SP4110	390	300	620	738*508*418	53.0
SP4132	480	360	780	900*600*582	77.0
SP4160	480	360	780	900*600*582	80.0
SP4200	480	361	1274	1390*600*590	111.5
SP4220	480	361	1274	1390*600*590	111.5

8 Alarm signal

When inverter show alarm signal with software default setting, keypad will show number as below

111	When inverter output frequency is lower than 35Hz for 60s, inverter shows alarm signal "111".
222	When pump are dry running for 60s and output current is smaller than P28.13 value, inverter shows alarm signal "222".
333	When solar panel voltage is lower than 170V (220V inverter) or 270V(380V inverter), inverter shows alarm signal "333".
444	When solar panel voltage higher than 800V, inverter shows alarm signal "444".
555	Inverter will show "555" alarm signal if water signal last 5s. After inverter shows alarm signal "555" and stop receiving water signal, inverter will wait for 900s and restart.
777	Inverter will show "777" alarm signal if water signal last 5s. After inverter shows alarm signal "777" and stop receiving water signal, inverter will wait for 900s and restart.
888	When inverter output current is too big and may damage pump, inverter shows alarm signal "888". If pump and cable are damaged, please choose new part. If pump have too heavy load, please choose bigger power inverter or make parameter 28.24 value up to 50.
999	When inverter output power is too big and may damage pump, inverter shows alarm signal "999".
994	When inverter output power is too big and may damage inverter, inverter shows alarm signal "994".
OH2	When inverter internet device temperature is over 90°C, inverter keypad will show OH2. Please reduce inverter site temperature, or choose bigger power inverter.
SPO	When inverter UVW terminal connect pump cable and output different voltage, inverter will show SPO to protect pump. If inverter run well after user disconnect pump cable and inverter, please check if pump and cable are damaged.

9 Customer Installation Record

--

Simple and Smart

Solarseeker

Solarseeker Ltd



0086 166 7506 1986



0086 166 7506 1986



0086 755 2882 5577



www.solarseeker.com.cn



service@solarseeker.com.cn



No 8, Shangxue Industrial Park, Shenzhen, China